



SPRAY POLYURETHANE FOAM DESIGN GUIDANCE

INSULATION AND AIR BARRIER REQUIREMENTS
OF THE 2012 I-CODES



Spray Foam
Coalition

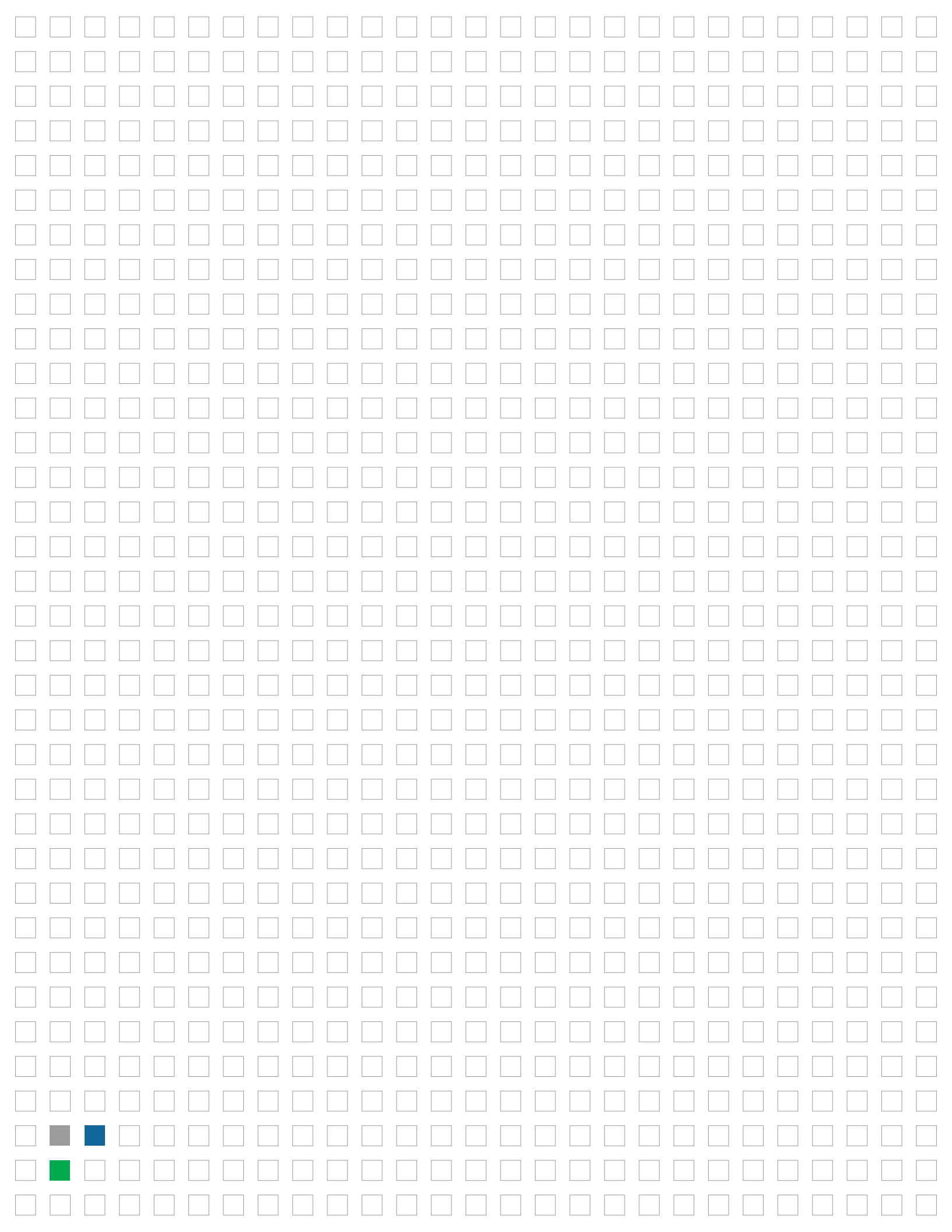



ABOUT THE COLLABORATION

THE CENTER FOR THE POLYURATHANES INDUSTRY (CPI) OF THE AMERICAN CHEMISTRY COUNCIL (ACC)

CPI serves as the voice of the polyurethanes industry in North America and works with polyurethane trade associations across the globe. CPI members are companies that produce and sell the raw materials and additives that are used to make polyurethane products, equipment used in the manufacture of polyurethanes, and companies engaged in end-use applications and the manufacture of polyurethane products.

THE SPRAY FOAM COALITION (SFC) OF THE CENTER FOR POLYURETHANES INDUSTRY

SFC champions the use of spray polyurethane foam in U.S. building and construction applications and promotes its economic, environmental and societal benefits while supporting the safe manufacture, transport, and application of spray polyurethane foam. SFC consists of manufacturers of spray polyurethane foam systems as well as suppliers of raw materials and machinery used to apply the foam.

THE CENTER FOR ENVIRONMENTAL INNOVATION IN ROOFING

The Center is a not-for-profit 501(c)(6) organization whose mission is to promote the development and use of environmentally responsible, high performance roof systems and technologies. Headquartered in Washington, D.C., the Center serves as a forum to draw together the entire roofing industry to the common cause of raising public awareness of the strategic value of our nation's roofs in reducing energy consumption, mitigating environmental impact and enhancing the quality of the buildings in which we live and work.

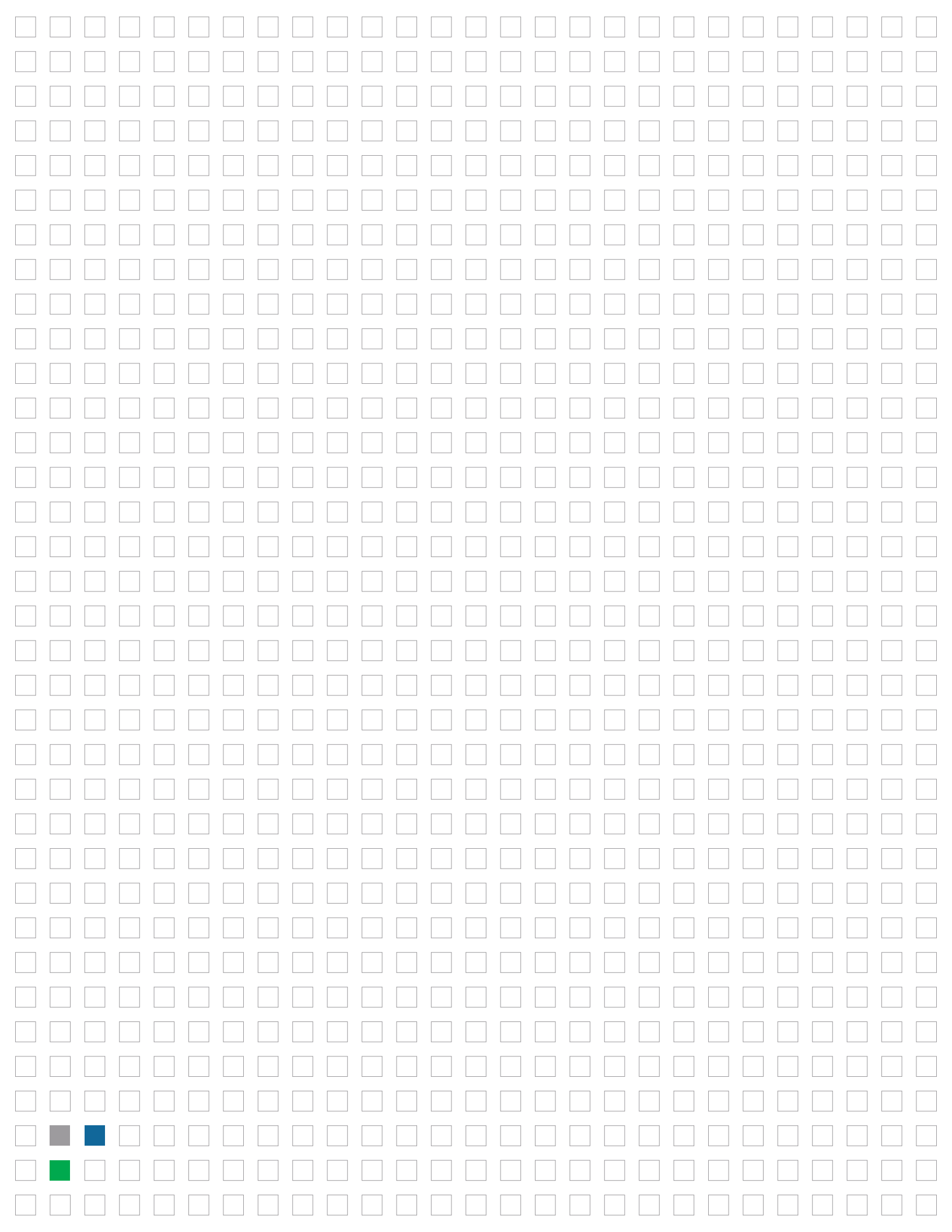



TABLE OF CONTENTS

INTRODUCTION 5

PURPOSE AND USE OF THE GUIDANCE DOCUMENT 6

NORTH AMERICAN CLIMATE ZONES 8

SPF USED AS ROOF INSULATION

COMMERCIAL BUILDINGS: ROOFS WITH SPF INSULATION ENTIRELY ABOVE DECK 10

COMMERCIAL BUILDINGS: ATTIC AND OTHER ROOFS 11

RESIDENTIAL BUILDINGS: WOOD-FRAMED ROOFS 13

WOOD-FRAMED ROOFS WITH ATTICS: RAFTER WRAPPING 14

SPF USED AS WALL INSULATION

COMMERCIAL BUILDINGS: WOOD-FRAMED WALLS 16

COMMERCIAL BUILDINGS: METAL-FRAMED WALLS 18

COMMERCIAL BUILDINGS: MASS WALLS 19

RESIDENTIAL BUILDINGS: WOOD-FRAMED WALLS 20

RESIDENTIAL BUILDINGS: MASS WALLS 21

SPF USED AS AN AIR BARRIER

INTRODUCTION 23

I-CODE REQUIREMENTS: COMMERCIAL BUILDINGS 24

SPF DETAILS: COMMERCIAL BUILDINGS 26

I-CODE REQUIREMENTS: RESIDENTIAL BUILDINGS 29

SPF DETAILS: RESIDENTIAL BUILDINGS 30

DISCLAIMER 34

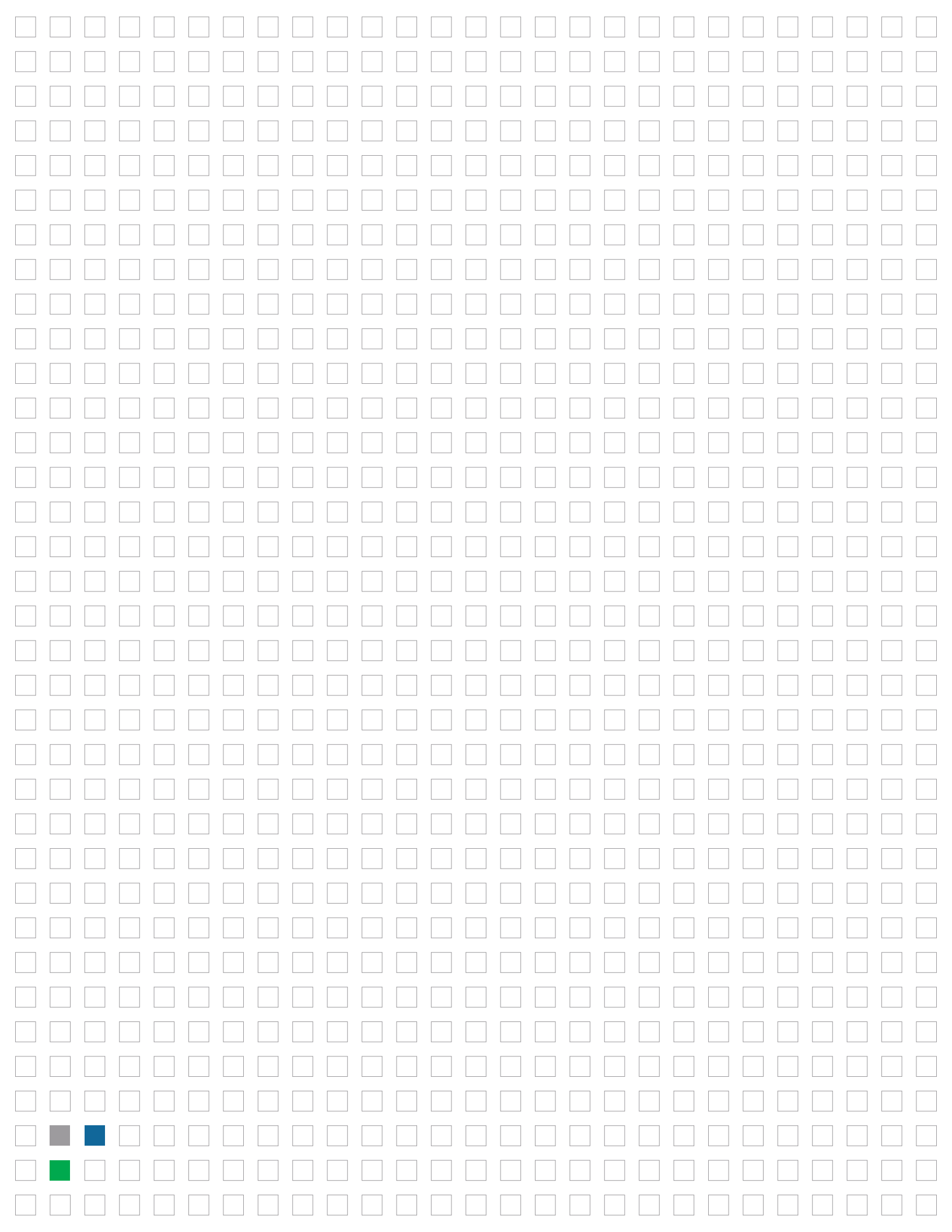



INTRODUCTION

THE INTERNATIONAL CODES (I-CODES) SERVE AS THE MODEL CODES FOR NEARLY ALL JURISDICTIONS WITHIN THE UNITED STATES. ENERGY EFFICIENCY PROVISIONS, SUCH AS REQUIREMENTS RELATED TO THE BUILDING THERMAL ENVELOPE, FALL WITHIN THE SCOPE OF THE INTERNATIONAL ENERGY CONSERVATION CODE (IECC). THE 2012 EDITION OF THE IECC INCORPORATES SEVERAL ADVANCES TO IMPROVE THE ENERGY EFFICIENCY OF COMMERCIAL AND RESIDENTIAL BUILDINGS. THESE ADVANCES INCLUDE: NEW AND MORE STRINGENT REQUIREMENTS FOR COMPONENTS OF THE BUILDING THERMAL ENVELOPE, AIR LEAKAGE TEST REQUIREMENTS AND OPTIONS AS WELL AS REQUIREMENTS FOR CONTINUOUS AIR BARRIERS. IN ADDITION TO THE PROVISIONS OF THE IECC, THE 2012 EDITION OF THE INTERNATIONAL GREEN CONSTRUCTION CODE (IGCC) WHEN ADOPTED WILL FURTHER INCREASE THE REQUIREMENTS OUTLINED IN THE 2012 IECC. THE IGCC IS NOT A STAND-ALONE CODE LIKE THE IECC OR THE INTERNATIONAL BUILDING CODE. IT IS INTENDED TO BE USED AS AN 'OVERLAY' CODE TO THE OTHER I-CODES, MEANING THAT ITS PROVISIONS ARE USED IN CONJUNCTION WITH THE OTHER CODES AND REGULATIONS ADOPTED BY THE JURISDICTION.

The energy efficiency provisions (i.e., thermal insulation requirements) within the I-Codes (model codes) include both prescriptive and performance pathways toward meeting the minimum requirements. The 2012 IECC prescriptive method includes minimum insulation R-value requirements for many building thermal envelope components, such as roofs and walls. The 2012 IECC includes U-factor options for the building thermal envelope components and allows a designer to calculate thermal resistance of these components based on the additive U-factors of the materials within the assemblies. By comparison, the 2012 IgCC does not include prescriptive methods; only performance methods are available to the designer. According to the building codes, ASHRAE 90.1 can be used as an alternative to the energy requirements in the 2012 IECC, while ASHRAE 189.1 can be used as a path to comply with the 2012 IgCC. While having these numerous options to reach compliance is beneficial to experts, it can be confusing to the non-expert.

For many in the design and construction communities, clarity on the applicable code provisions may prove more preferable to numerous, confusing options when it comes to compliance with the energy efficiency, insulation and air barrier compliance requirements of the I-Codes. For building thermal envelope components that are frequently replaced or renovated, such as roofs and walls, simplified, straightforward guidance on building thermal envelope requirements can help the construction industry.



INTRODUCTION: PURPOSE AND USE OF GUIDE

PURPOSE OF THE GUIDANCE DOCUMENT

In an effort to provide assistance for the building designer, the Spray Foam Coalition (SFC) and the Center for Environmental Innovation in Roofing (The Center) have developed this guidance document to provide building designers with easy-to-use information about spray polyurethane foam (SPF) for use as wall and roof insulation and as an air barrier. Air barrier information and R-value requirements for commercial and residential buildings complying with the 2012 IECC and 2012 IgCC are provided.

USE OF THE GUIDANCE DOCUMENT

This guidance document provides information relative to SPF used as:

1. Roof Insulation
2. Wall Insulation
3. An Air Barrier

Determining the Appropriate Thermal Resistance Value (R-Value). In order to identify the appropriate building code defined prescriptive R-value for a roof or wall assembly:

1. Determine if the application is as roof insulation or wall insulation. SPF products designed for roof insulation and wall insulation are different products having different thermal resistance and other requirements.
2. Determine the applicable code. The 2012 IECC and the 2012 IgCC have different values for roof and wall thermal resistance requirements.
3. Determine if the building is commercial or residential. Commercial and residential buildings have different roof and wall thermal resistance requirements.
4. Identify the type of roof or wall assembly. This guidance document provides information about the most common roof and wall assemblies in commercial and residential buildings. It is not an exhaustive list of all assemblies.
 - a. Roofs with Insulation Entirely Above Deck (Commercial)
 - b. Roof with Attics and Other (Commercial)
 - c. Wood-Framed Walls (Commercial)
 - d. Metal-Framed Walls (Commercial)
 - e. Mass Walls (Commercial)
 - f. Wood-Framed Roofs (Residential)
 - g. Wood-Framed Walls (Residential)
 - h. Mass Walls (Residential)
5. Identify the Climate Zone. Roof and wall thermal requirements vary between climate zones.
6. Select the building code defined prescriptive R-value from the table within this guidance document based on the above identifications.

Air Barriers. This guidance document provides a brief overview of 2012 IECC requirements and offers a variety of guidance on the effective use of SPF to meet these air barrier requirements. The guidance on SPF in this document is based on provisions of the 2012 IECC that identify several SPF systems as prescriptive air barrier materials. Consult the 2012 IECC and 2012 IgCC for additional information and how the model building codes apply to your specific situation.



LIMITATIONS OF THE GUIDANCE DOCUMENT

Prescriptive Design Path. This guidance document provides prescriptive R-values for the 2012 IECC and calculated R-values for the 2012 IgCC. In many cases, the 2012 IgCC R-values are based on U-factor analysis specific to the exact construction type and components used within a roof or wall. Please refer to the footnotes beneath each R-value chart for additional information.

As the design community and building industry become more aware of the thermal requirements of the building envelope, the determination of R-value becomes more critical. For example, the R-value of a roof is not the simple measurement of insulation thickness in the field of the roof. The R-value of the entire roof assembly, viewed as a complete rooftop system, is now the focus of the building envelope industry.

Conditioned Buildings. This guidance document provides insulation and air-barrier information for conditioned buildings only. For information relative to semi-heated buildings and semi-heated portions of buildings, see the appropriate code.

Additional Code Requirements. This guidance document is limited to insulation and air barrier requirements within the 2012 IECC and 2012 IgCC. Accordingly, consult the 2012 IECC and 2012 IgCC for a more thorough understanding of insulation and air barrier requirements. This guidance document does not address any other design or safety requirements of any of the other I-Codes.

A NOTE ABOUT SPF

SPF is a unique product in the building, in part, because it is manufactured on site. SPF products are extremely adaptable to various shapes and forms allowing for application in places otherwise difficult to reach.

A NOTE ABOUT THE IgCC

As stated previously, the IgCC is an overlay code intended for use in conjunction with other I-codes. The 2012 IgCC is unique in its layout and use. Usually, each jurisdiction determines which sections of the IgCC apply, and in many cases to what extent they apply. The jurisdiction fills out IgCC Table 302.1., which becomes the Jurisdictional Requirements. Because Table 302.1 provides many options, the Jurisdictional Requirements are specific to each jurisdiction that adopts the 2012 IgCC.

According to Section 601.3 of the 2012 IgCC, the energy efficiency requirements can be met with performance or prescriptive requirements. This guidance document provides information on calculated R-values that can meet the thermal resistance requirements of the 2012 IgCC.

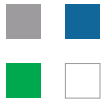

INTRODUCTION: NORTH AMERICAN CLIMATE ZONES

U.S. & CANADA I-CODES / ASHRAE ZONES

- CLIMATE ZONE 1
- CLIMATE ZONE 2
- CLIMATE ZONE 3
- CLIMATE ZONE 4
(EXCEPT MARINE)
- CLIMATE ZONE 5 & 4 MARINE
- CLIMATE ZONE 6
- CLIMATE ZONE 7 & 8

U.S. HUMIDITY ZONES

- A MOIST
- B DRY
- C MARINE

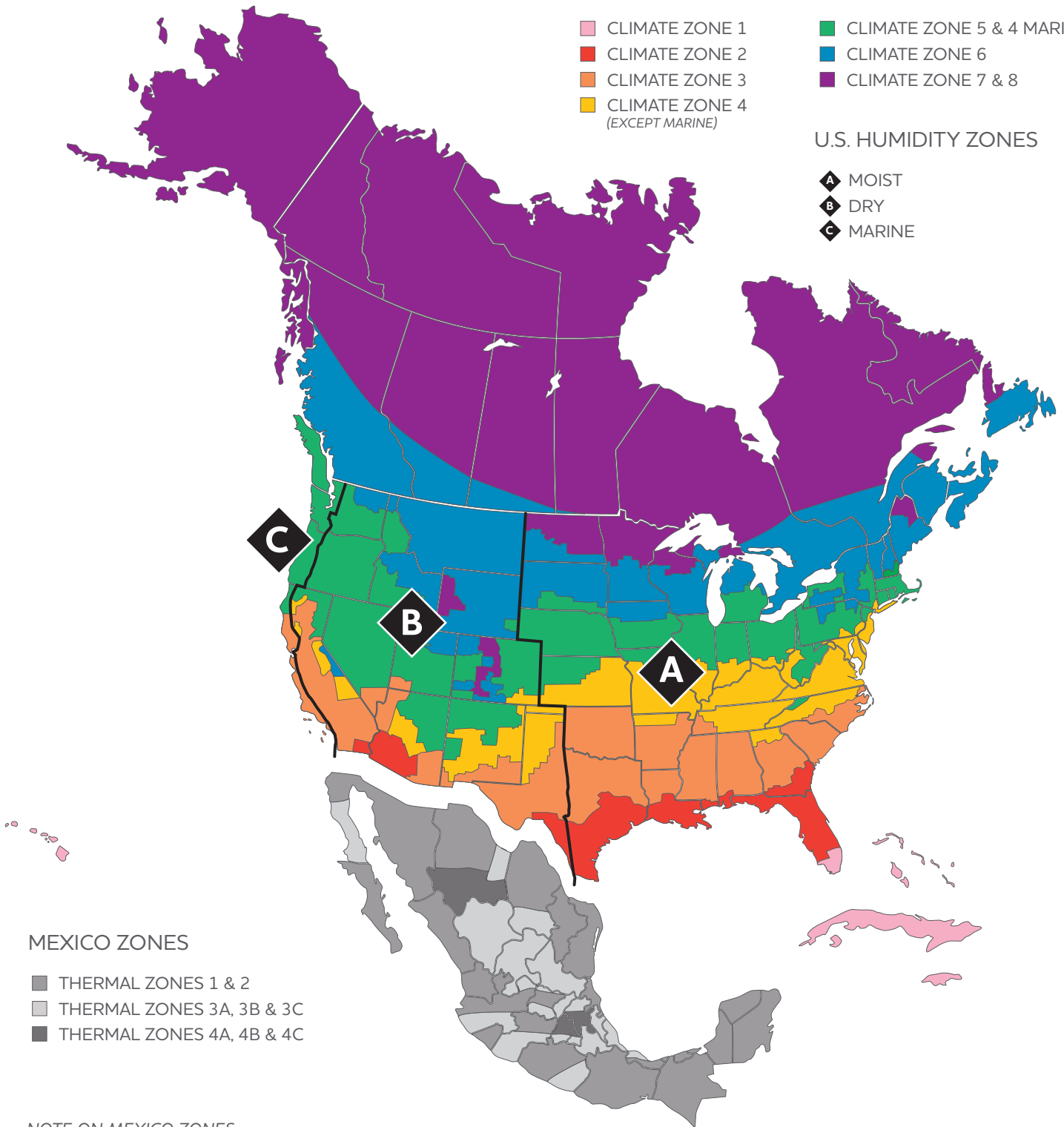

MEXICO ZONES

- THERMAL ZONES 1 & 2
- THERMAL ZONES 3A, 3B & 3C
- THERMAL ZONES 4A, 4B & 4C

NOTE ON MEXICO ZONES

Mexico does not recognize the I-Code/ASHRAE Climate Zones used in the United States and Canada. However, Mexico does recognize multiple thermal zones based on elevation and other climate variances. Information on these climate zones is contained in a document produced by ONNCEE entitled "Building Industry—Insulation—'R' Value for the Housing Envelope by Thermal Zone for Mexican Republic—Specification and Verification." For additional resources, visit www.onnccc.org.mx.

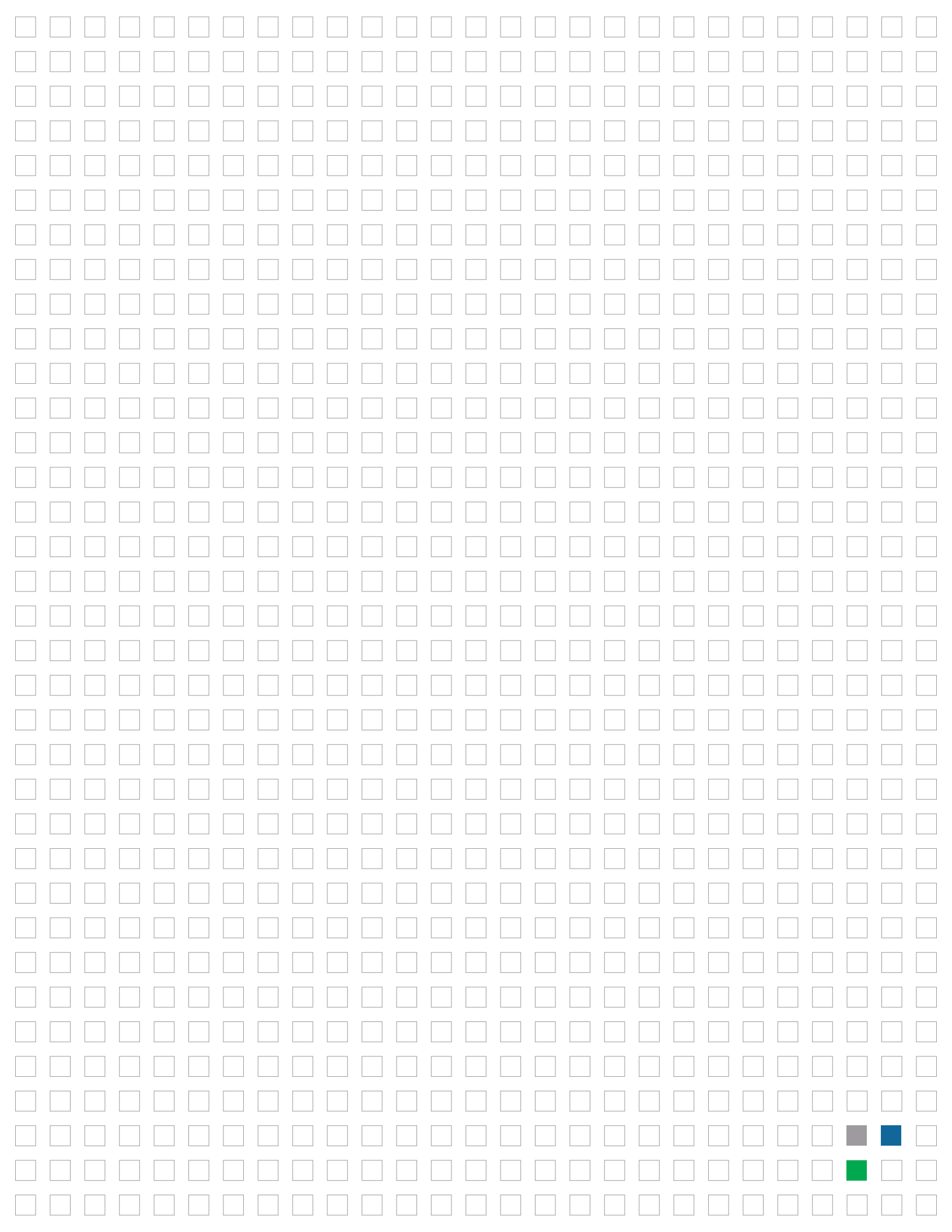



SPF USED AS ROOF INSULATION

COMMERCIAL BUILDINGS: ROOFS WITH SPF INSULATION ENTIRELY ABOVE DECK¹

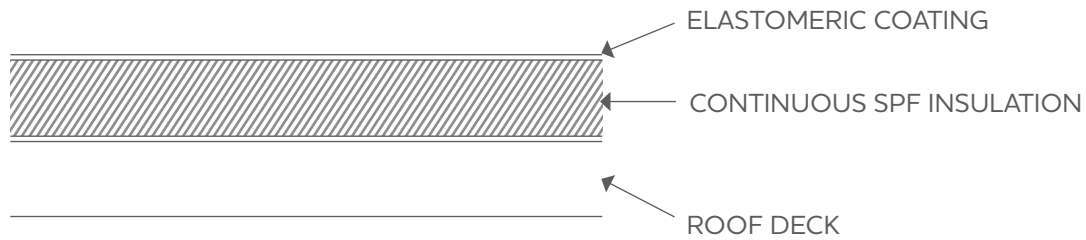

CLIMATE ZONE	R-VALUE: CONTINUOUS ABOVE-DECK INSULATION	
	2012 IECC R-VALUE ²	2012 IgCC R-VALUE ³
1	20.0	22.5
2	20.0	22.5
3	20.0	22.5
4	25.0	28.0
5	25.0	28.0
6	30.0	34.0
7	35.0	39.0
8	35.0	39.0

NOTES TO THE TABLE

1. This table applies to low-slope roofs (less than or equal to 2:12 slope) on nonresidential buildings and multi-family dwellings greater than three stories in height.
2. 2012 IECC R-value as shown in 2012 IECC Table C402.2.
3. 2012 IgCC R-value is determined by reducing the overall roof assembly U-factor in 2012 IECC Table C402.1.2 for "roofs with insulation entirely above deck" by 10% and converting the assembly U-factor to the corresponding insulation R-value reduced by 0.17R for exterior air film and 0.61R for interior air film. Resultant R-values rounded to the nearest 0.5 R. See ASHRAE 90.1-2010 Normative Appendix A and 2012 IgCC Section 605.1.1 for additional information.

OTHER DESIGN NOTES

1. Residential Portion (i.e. Group R occupancies) of a Commercial Building. In all Climate Zones, any residential portion of the commercial building requires the same R-value as the commercial portion of the building. See 2012 IECC Table C402.2.
2. New Construction and Reroofing. The R-values shown above apply to new low-slope commercial roof systems and to the reroofing of low-slope commercial roof systems where "the sheathing or insulation is exposed" during reroofing. See IECC 2102 Chapter C101.4.3, Exception 5.
3. Cool Roof Coverings. Low-slope roof coverings (less than or equal to 2:12 slope) over cooled conditioned spaces in Climate Zones 1, 2 and 3 shall meet minimum solar reflectance and emittance requirements. See IECC 2102 Section C402.2.1.1.
4. Roof Air Barrier. See "SPF Used as an Air Barrier" in this guidance document.
5. Skylight curbs are required to be insulated to a minimum R-5. See 2012 IECC Section 402.2.1.

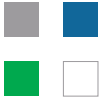

SPF USED AS ROOF INSULATION

COMMERCIAL BUILDINGS: ATTIC AND OTHER ROOFS

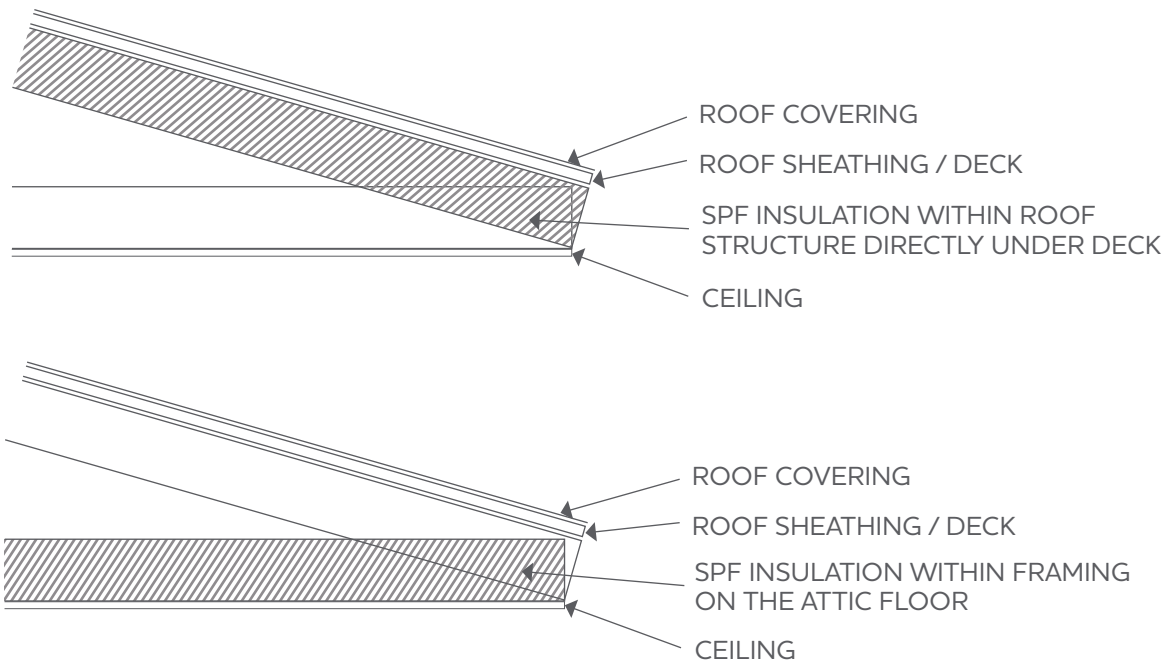

CLIMATE ZONE	R-VALUE: INSULATION WITHIN ROOF STRUCTURE ⁴	
	2012 IECC R-VALUE ²	2012 IgCC R-VALUE ³
1	38.0	43.0
2	38.0	43.0
3	38.0	43.0
4	38.0	43.0
5	38.0	43.0
6	49.0	55.0
7	49.0	55.0
8	49.0	55.0

NOTES TO THE TABLE

1. This table applies to steep-slope roofs (greater than 2:12 slope) on nonresidential buildings and multi-family dwellings greater than three stories in height.
2. 2012 IECC R-value as shown in 2012 IECC Table C402.2.
3. 2012 IgCC R-value is determined by reducing the overall roof assembly U-factor in 2012 IECC Table C402.1.2 for "attic and other roofs" by 10% and converting the assembly U-factor to the corresponding insulation R-value as interpolated using ASHRAE 90.1-2010 Normative Appendix A: Table A2.4, Assembly U Factors for Attic Roofs with Wood Joists (Standard Framing). Resultant R-values rounded to nearest 0.5 R. Note: Resultant R-value will be slightly lower for attic roofs with advanced wood framing and slightly higher for single-rafter roofs and attic roofs with steel joists. See ASHRAE 90.1-2010 Normative Appendix A and IgCC Section 605.1.1 for additional information.
4. Installed either directly under the roof deck or directly above the ceiling (See illustrations).
5. See Section "WOOD-FRAMED ROOFS WITH ATTICS: RAFTER WRAPPING" for additional discussion.



OTHER DESIGN NOTES

1. Residential Portion (i.e., Group R occupancies) of a Commercial Building. In all Climate Zones except Marine 4 and 5, any residential portion of the commercial building requires the same R-value as the commercial portion of the building. In Climate Zones Marine 4 and 5, the R-value is increased to the next highest climate zone. See 2012 IECC Table C402.2.
2. New Construction and Reroofing. The R-values shown above apply to new low-slope commercial roof systems and to the reroofing of low-slope commercial roof systems where “the sheathing or insulation is exposed” during reroofing. See 2012 IECC Chapter C101.4.3, Exception 5.
3. Cool Roof Coverings. Low-slope roof coverings (greater than or equal to 2:12 slope) over cooled conditioned spaces in Climate Zones 1, 2 and 3 shall meet minimum solar reflectance and emittance requirements. See 2012 IECC Section C402.2.1.1.
(Note: It is not common to have commercial structures with attics that are less than 2:12.)
4. Roof Air Barrier. See “SPF Used as an Air Barrier” in this guidance document.
5. Skylight curbs are required to be insulated to a minimum R-5. See 2012 IECC Section 402.2.1.

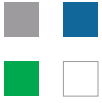

SPF USED AS ROOF INSULATION

RESIDENTIAL BUILDINGS: WOOD-FRAMED ROOFS

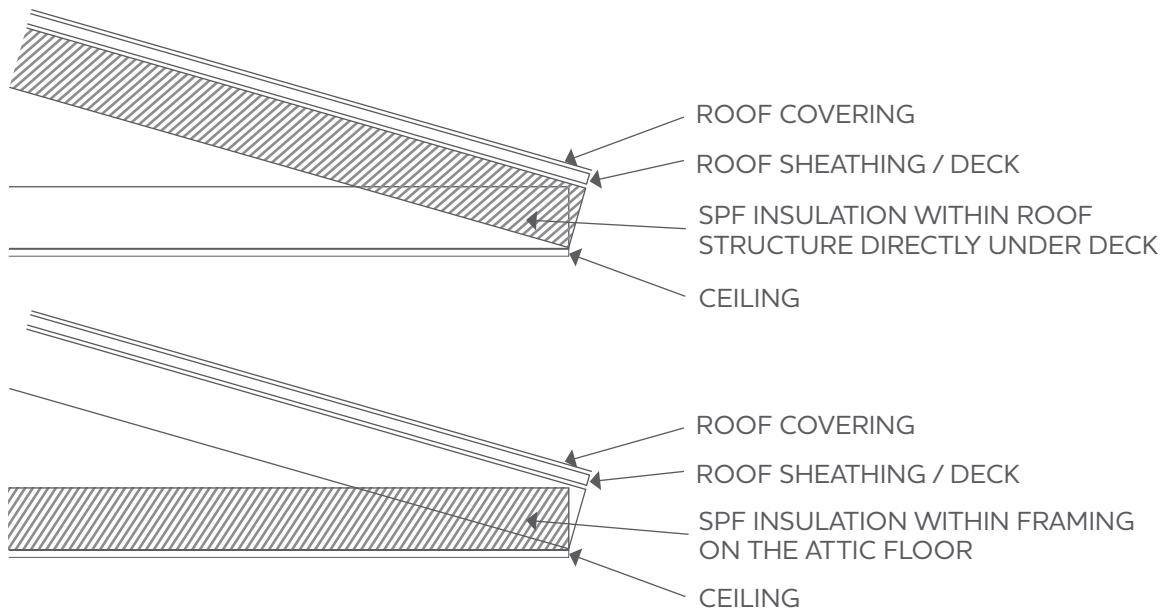

CLIMATE ZONE	R-VALUE: INSULATION WITHIN ROOF STRUCTURE ⁴	
	2012 IECC R-VALUE ²	2012 IgCC R-VALUE ³
1	30	n/a
2	38	n/a
3	38	n/a
4	49	n/a
5	49	n/a
6	49	n/a
7	49	n/a
8	49	n/a

NOTES TO THE TABLE

1. This table applies to steep-slope roofs (greater than 2:12 slope) on detached residential buildings (one- or two-family) and multi-family dwellings three stories or less in height.
2. 2012 IECC R-value as shown in 2012 IECC Table R402.1.1 for "Ceiling R-Value."
3. The 2012 IgCC does not include provisions for detached residential buildings (one- or two-family) and multi-family dwellings three stories or less in height.
4. Installed either directly under the roof deck or directly above the ceiling (See illustrations).
5. See Section "WOOD-FRAMED ROOFS WITH ATTICS: RAFTER WRAPPING" for additional discussion.

OTHER DESIGN NOTES

1. Eave Baffles. In vented attics, eave baffles are necessary at soffit and eave vents to allow airflow. 2012 IECC Section R402.2.3 requires baffles for "... air permeable insulations in vented attics ..."
2. Access hatches and doors. To achieve the code required R-value, access hatches and doors should be covered with insulation at an R-value that is equivalent to that of the adjoining ceiling.



SPF USED AS ROOF INSULATION

WOOD-FRAMED ROOFS WITH ATTICS: RAFTER WRAPPING

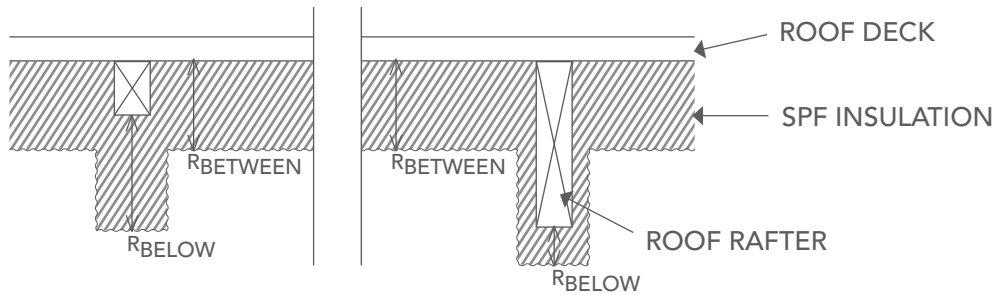

PRESCRIPTIVE R-VALUE	R30		R38		R49		R43 (ASSEMBLY)		R55 (ASSEMBLY)	
PRESCRIPTIVE U-FACTOR	0.035		0.03		0.026		0.023		0.018	
R-VALUE BETWEEN RAFTERS	26.8		31.5		36.7		41.7		53.8	
R-VALUE BELOW RAFTER										
RAFTER SIZE	LD	MD	LD	MD	LD	MD	LD	MD	LD	MD
2x4	19.9	18.3	24.6	22.8	29.6	27.7	34.6	32.4	46.5	44.2
2x6	16.5	14.9	21.1	19.2	26.0	23.9	30.9	28.5	42.7	39.7
2x8	13.7	12.2	18.2	22.8	23.0	20.9	27.9	25.4	39.5	36.5
2x10	10.6	9.3	15.0	13.4	19.8	17.8	24.5	22.2	36.1	32.9
2x12	7.8	6.7	12.0	10.6	16.7	14.8	21.3	19.1	32.7	29.6

NOTES TO THE TABLE

1. SPF can be sprayed under the deck and around the rafters, in addition to being sprayed between rafters in roofs with attics. This application is called "stud wrapping" or "rafter wrapping." The table above provides R-values of SPF to be installed under the sloped roof deck and around the rafters in order to meet the R-values shown in this guidance document in the table for "SPF Used as Roof Insulation/Commercial Buildings: Attics and Other Roofs" and "SPF Used as Roof Insulation/Residential Buildings: Attics and Other Roofs."
2. In these calculations, the R-value of SPF used for closed cell SPF is 6.2/inch. The R-value of SPF used for open cell SPF is 3.6/inch.
3. Rafter spacing has little effect on the R-value required when the "rafter wrapping" method is used. The chart is applicable to rafter spacings of 16" on center and 24" on center.
4. Wrapping the rafters can use less foam to achieve the required R-value relative to only installing SPF insulation between rafters.
5. "Other Design Notes" in the tables on the previous pages are applicable for commercial and residential installations.

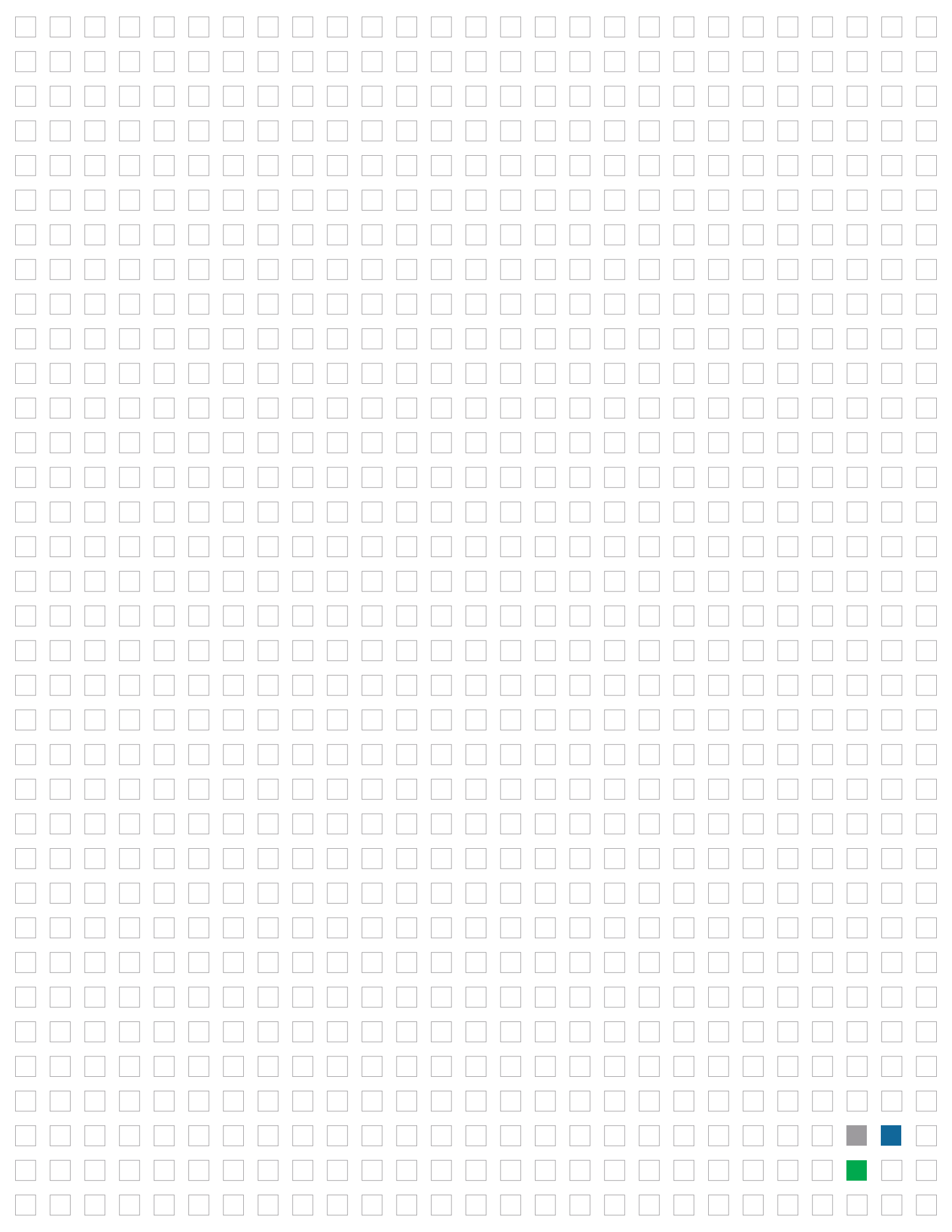



SPF USED AS WALL INSULATION

COMMERCIAL BUILDINGS: WOOD-FRAMED WALLS

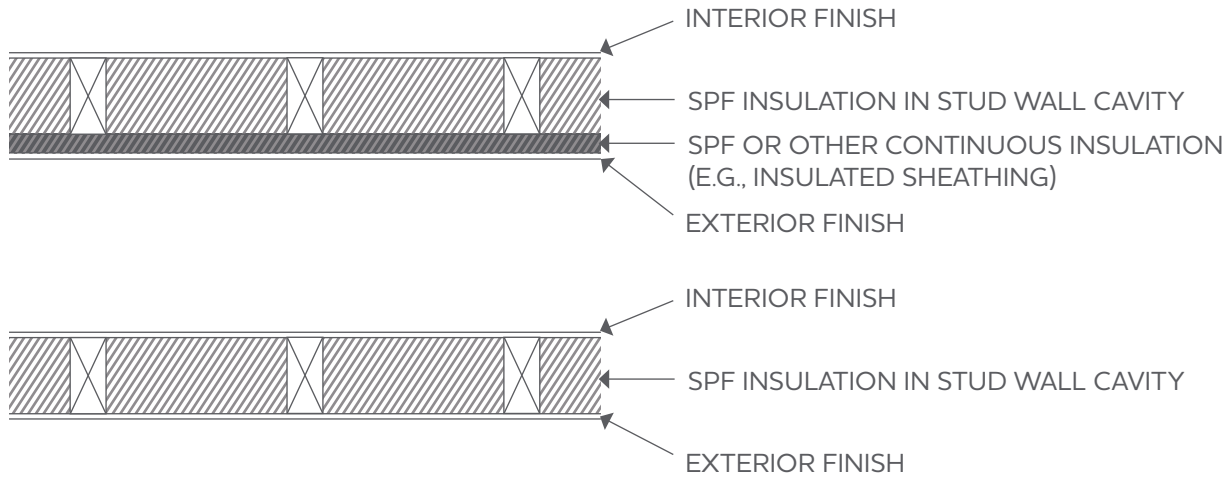

CLIMATE ZONE	R-VALUE REQUIREMENT				
	STUD SIZE	2012 IECC R-VALUE ²		202 IgCC R-VALUE ³	
		In Cavity	Continuous	In Cavity	Continuous
1 (2x4)	13	3.8	14.5	3.8	
1 (2x6)	20	N/A	22.5	n/a	
2 (2x4)	13	3.8	14.5	3.8	
2 (2x6)	20	n/a	22.5	n/a	
3 (2x4)	13	3.8	14.5	3.8	
3 (2x6)	20	n/a	22.5	n/a	
4 (2x4)	13	3.8	14.5	3.8	
4 (2x6)	20	n/a	22.5	n/a	
5 (2x4)	13	3.8	14.5	3.8	
5 (2x6)	20	n/a	22.5	n/a	
6 (2x4)	13	7.5	15	7.5	
6 (2x6)	20	3.8	23	3.8	
7 (2x4)	13	7.5	15	7.5	
7 (2x6)	20	3.8	23	3.8	
8 (2x4)	13	15.6	16.5	15.6	
8 (2x6)	20	10	23.5	10	



NOTES TO THE TABLE

1. This table applies to above-grade walls in nonresidential buildings and low-slope multi-family dwellings greater than three stories in height.
2. 2012 IECC R-value as shown in 2012 IECC Table C402.2. When required, continuous insulation is intended to be located on the exterior of the cavity. Note: The 2012 IECC R-value table assumes that either 2x4 or 2x6 wood studs are spaced 16" on center and the 3 ½" or 5 ½" cavity is filled with the maximum allowable amount of mineral or glass fiber batt insulation. In the case of SPF insulation, because it has a higher R-value per inch than batt insulation, the full cavity may not need to be filled to obtain the required R-value.
3. 2012 IgCC R-value is determined by reducing the U-value in 2012 IECC Table C402.1.2 for "wood framed walls above grade" by 10%, converting the resultant U-value to the corresponding interpolated R-value per Table A3.4 Assembly U Factors for Wood-Frame Walls, Normative Appendix A, ASHRAE 90.1-2010, and adding the resultant increase in R-value in SPF insulation to the cavity portion of the assembly. Resultant R-values rounded to nearest 0.5 R. Note: Resultant R-values will be slightly lower for walls with stud spacing greater than 16" on center. See ASHRAE 90.1-2010 Normative Appendix A and 2012 IgCC Section 605.1.1 for additional information.

OTHER DESIGN NOTES

1. Residential Portion (i.e. Group R occupancies) of a Commercial Building. In all Climate Zones, any residential portion of the commercial building requires the same R-value as the commercial portion of the building for cavity insulation; however, the R-value for continuous insulation is increased in Climate Zones Marine 4 and 5 to the next highest climate zone. See 2012 IECC Table C402.2.



SPF USED AS WALL INSULATION

COMMERCIAL BUILDINGS: METAL-FRAMED WALLS

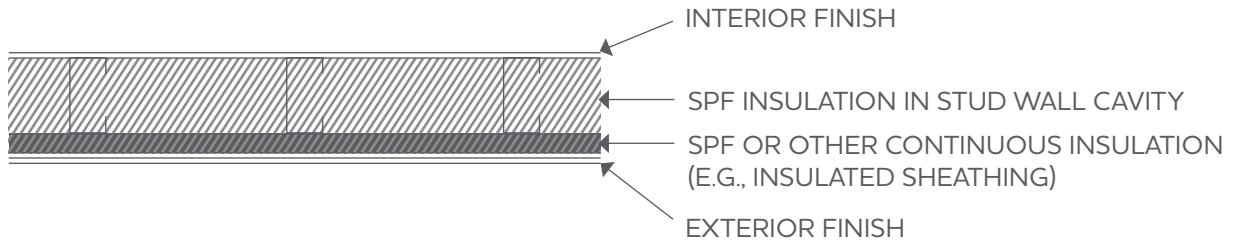

CLIMATE ZONE	R-VALUE REQUIREMENT			
	2012 IECC R-VALUE ²		202 IgCC R-VALUE ³	
	In Cavity	Continuous	In Cavity	Continuous
1	13.0	5.0	14.5	5.0
2	13.0	5.0	14.5	5.0
3	13.0	7.5	14.5	7.5
4	13.0	7.5	14.5	7.5
5	13.0	7.5	14.5	7.5
6	13.0	7.5	14.5	7.5
7	13.0	7.5	14.5	7.5
8	13.0	7.5	14.5	7.5

NOTES TO THE TABLE

- This table applies to above-grade walls in nonresidential buildings and low-slope multi-family dwellings greater than 3 stories in height. Assumes 3½" metal studs spaced 16" on center.
- 2012 IECC R-value as shown in 2012 IECC Table C402.2. Continuous insulation is intended to be located on the exterior of the cavity. Note: The 2012 IECC R-value table assumes that either 2x4 or 2x6 metal studs are spaced 16" on center and the 3½" or 5½" cavity is filled with the maximum allowable amount of mineral or glass fiber batt insulation. In the case of SPF insulation, however, the full cavity may not need to be filled to obtain the required R-value.
- 2012 IgCC R-value is determined by reducing the U-value in 2012 IECC Table C402.1.2 for "metal framed walls above grade" by 10%, converting the resultant U-value to the corresponding interpolated R-value per Table A3.3 Assembly U Factors for Metal-Frame Walls, Normative Appendix A, ASHRAE 90.1-2010, and adding the resultant increase in R-value in SPF insulation to the cavity portion of the assembly. Resultant R-values rounded to nearest 0.5 R. Note: Resultant R-values will be slightly lower for walls with stud spacing greater than 16" on center. See ASHRAE 90.1-2010 Normative Appendix A and 2012 IgCC Section 605.1.1 for additional information.

OTHER DESIGN NOTES

- Residential Portion (i.e. Group R occupancies) of a Commercial Building. In all Climate Zones, any residential portion of the commercial building requires the same R-value as the commercial portion of the building for stud wall cavity insulation; however, the R-value for continuous insulation is increased in Climate Zones 2, 7 and 8. See 2012 IECC Table C402.2.

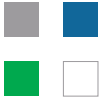

SPF USED AS WALL INSULATION

COMMERCIAL BUILDINGS: MASS WALLS²

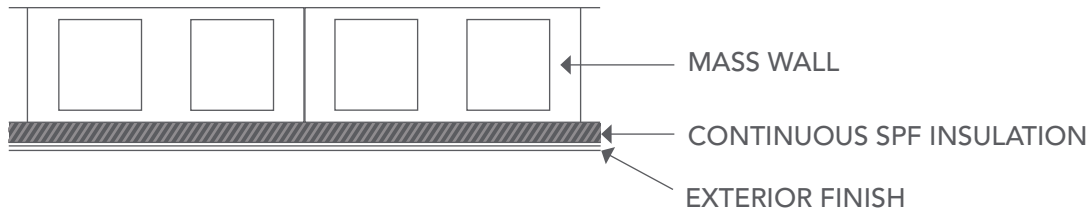

CLIMATE ZONE	R-VALUE: CONTINUOUS INSULATION	
	2012 IECC R-VALUE ³	2012 IgCC R-VALUE ⁴
1	5.5	6.0
2	5.5	6.0
3	7.5	8.0
4 Except Marine	8.0	9.0
5 Plus Marine 4	11.5	12.5
6	11.5	12.5
7	15.0	16.0
8	15.0	16.0

NOTES TO THE TABLE

1. This table applies to above-grade walls in nonresidential buildings and low-slope multi-family dwellings greater than three stories in height.
2. Mass wall assumed to be 8" medium weight solid grouted concrete block and continuous insulation assumed to be uninterrupted by framing. See Table A3.1A Assembly U Factors for Above-Grade Concrete and Masonry Walls, Normative Appendix A, ASHRAE 90.1-2010. Other types of concrete and masonry mass wall assemblies will have different insulation R-value requirements.
3. The 2012 IECC continuous insulation R-value is determined by converting the U-value for "mass walls above grade" as shown in 2012 IECC Table C402.1.2 to the corresponding R-value for "continuous insulation uninterrupted by framing" as shown for ASHRAE 90.1-2010 Table A3.1A, Normative Appendix A, for 8" medium weight solid grouted concrete block walls.
4. For the 2012 IGCC, R-value is determined by reducing the U-value in 2012 IECC Table C402.1.2 for "mass walls above grade" by 10% and converting the resultant U-value to the corresponding interpolated R-value for "continuous insulation uninterrupted by framing" as shown for ASHRAE 90.1-2010 Table A3.1A, Normative Appendix A, for 8" medium weight solid grouted concrete block walls. Resultant R-values rounded to nearest 0.5 R. See 2012 IGCC Section 605.1.1 for additional information.

OTHER DESIGN NOTES

1. Residential Portion (i.e. Group R occupancies) of a Commercial Building. In Climate Zones 2, 3, 4, 5 and 6, any residential portion of the commercial building requires increased R-value. See 2012 IECC Table C402.2.



SPF USED AS WALL INSULATION

RESIDENTIAL BUILDINGS: WOOD-FRAMED WALLS

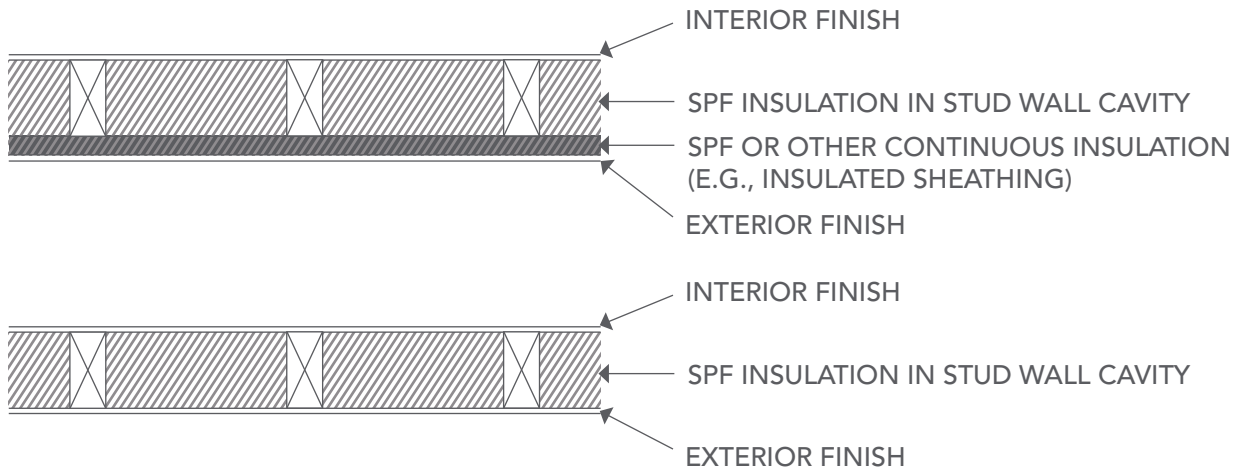

CLIMATE ZONE	R-VALUE REQUIREMENT				
	STUD SIZE	2012 IECC R-VALUE ²		202 IgCC R-VALUE ³	
		In Cavity	Continuous	In Cavity	Continuous
	1 (2x4)	13.0	n/a	n/a	n/a
	1 (2x6)	13.0	n/a	n/a	n/a
	2 (2x4)	13.0	n/a	n/a	n/a
	2 (2x6)	13.0	n/a	n/a	n/a
	3 (2x4)	13.0	5.0	n/a	n/a
	3 (2x6)	20.0	n/a	n/a	n/a
	4 (2x4)	13.0	5.0	n/a	n/a
	4 (2x6)	20.0	n/a	n/a	n/a
	5 (2x4)	13.0	5.0	n/a	n/a
	5 (2x6)	20.0	n/a	n/a	n/a
	6 (2x4)	13.0	10.0	n/a	n/a
	6 (2x6)	20	5.0	n/a	n/a
	7 (2x4)	13.0	10.0	n/a	n/a
	7 (2x6)	20	5.0	n/a	n/a
	8 (2x4)	13.0	10.0	n/a	n/a
	8 (2x6)	20	5.0	n/a	n/a

NOTES TO THE TABLE

1. This table applies to above-grade walls in detached residential buildings (one- or two-family) and multi-family dwellings three stories or less in height.
2. 2012 IECC R-value as shown in 2012 IECC Table R402.1.1 for "Wood-Framed Walls." When required, continuous insulation is intended to be located on the exterior of the cavity. Note: The IECC R-value table assumes that either 2x4 or 2x6 wood studs are spaced 16" on center and the 3 1/2" or 5 1/2" cavity is filled with the maximum allowable amount of mineral or glass fiber batt insulation. In the case of SPF insulation, however, the full cavity may not need to be filled to obtain the required R-value.
3. The 2012 IgCC does not include provisions for detached residential buildings (one- or two-family) and multi-family dwellings three stories or less in height.



SPF USED AS WALL INSULATION

RESIDENTIAL BUILDINGS: MASS WALLS²

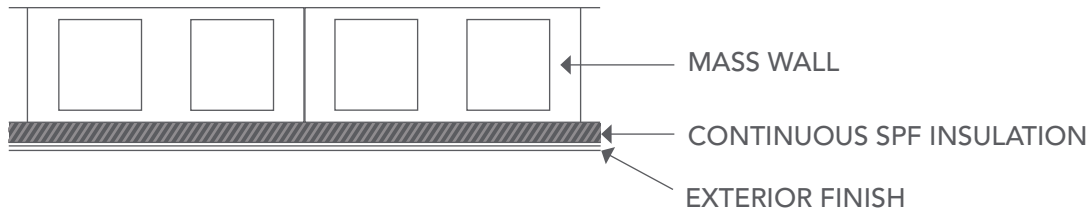

CLIMATE ZONE	R-VALUE: CONTINUOUS INSULATION	
	2012 IECC R-VALUE ³	2012 IgCC R-VALUE ⁴
1	3.5	n/a
2	4.5	n/a
3	8.5	n/a
4 Except Marine	8.5	n/a
5 Plus Marine 4	10.5	n/a
6	15.0	n/a
7	16.0	n/a
8	16.0	n/a

NOTES TO THE TABLE

1. This table applies to above-grade walls in detached residential buildings (one- or two-family) and multi-family dwellings three stories or less in height.
2. Mass wall assumed to be 8" medium weight solid grouted concrete block and continuous insulation assumed to be uninterrupted by framing. See Table A3.1A Assembly U Factors for Above-Grade Concrete and Masonry Walls, Normative Appendix A, ASHRAE 90.1-2010. Other types of concrete and masonry mass wall assemblies will have different insulation R-value requirements.
3. The 2012 IECC continuous insulation R-value is determined by converting the U-value for "mass walls" as shown in 2012 IECC Table R402.1.3 to the corresponding R-value for "continuous insulation uninterrupted by framing" as shown for ASHRAE 90.1-2010 Table A3.1A, Normative Appendix A, for 8" medium weight solid grouted concrete block walls.
4. The 2012 IgCC does not include provisions for detached residential buildings (one- or two-family) and multi-family dwellings three stories or less in height.

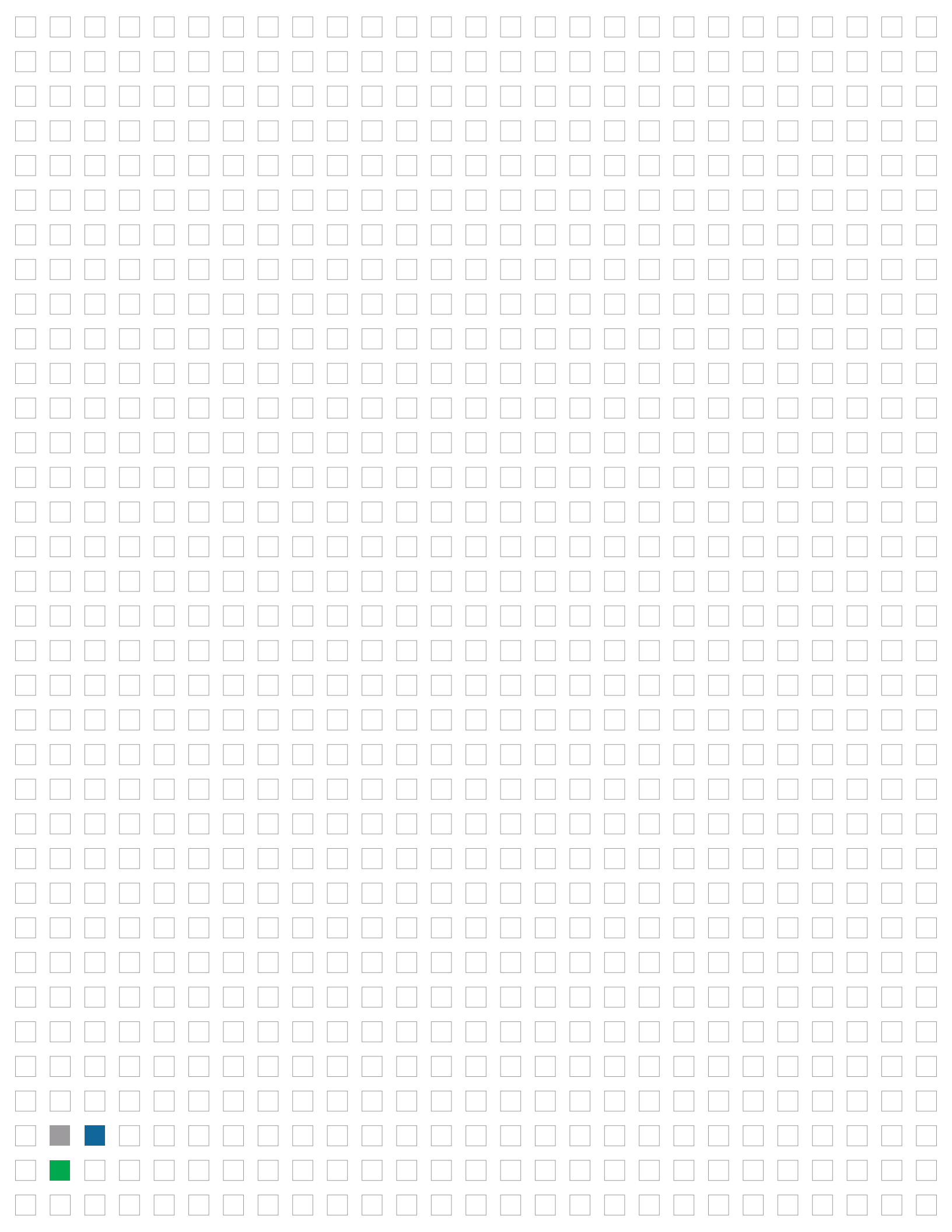



SPF USED AS AN AIR BARRIER

THE 2012 IECC NOW INCLUDES REQUIREMENTS FOR CONTINUOUS AIR BARRIERS BECAUSE OF THE AWARENESS THAT PREVENTING AIR LEAKAGE IS AS IMPORTANT TO ENERGY EFFICIENCY AS INCLUDING THERMAL INSULATION. RELATIVE TO VAPOR DIFFUSION, AIR LEAKAGE CAN MOVE UP TO 30 TIMES MORE MOISTURE. LEAKING AIR NOT ONLY CARRIES MOISTURE, IT MOVES A GREAT AMOUNT OF HEAT (I.E., ENERGY). IT IS UNDERSTANDABLE THAT MANAGING AIR LEAKAGE THROUGH THE BUILDING THERMAL ENVELOPE IS CRITICAL TO ENERGY EFFICIENCY.

Air barriers are relatively new to the construction industry, so there is still some confusion regarding how they are defined, evaluated and used in the building envelope.

The 2012 IECC defines an air barrier as “material(s) assembled and joined together to provide a barrier to air leakage through the building envelope. An air barrier may be a single material or a combination of materials.” Specific requirements for air barrier construction are included in Section C402.4.1.1. of the 2012 IECC.

An air barrier requires certain characteristics to perform properly. An air barrier:

- Must be **continuous**, without gaps or openings of any size;
- Can be **located anywhere** within the envelope. Location is based on ease of detailing and installation;
- **Does not need to resist vapor movement**. It does not need to be a vapor retarder; and
- Must be strong to **resist positive and negative pressures**.

Air barriers and vapor retarders are not the same thing; however, it is possible that a single product is able to perform both functions. In contrast to air barrier requirements, vapor retarders are not required to be continuous. Vapor retarders must be located in the correct location within roofs and walls; this is based on the climate zone, vapor drive and materials used for construction, and details can be found in the building code.

With respect to SPF, both open-cell and closed-cell products will perform as an air barrier at a sufficient thickness; however, as of the date of publication of this document only the closed-cell products have the performance characteristics that meet code requirements for a Class II vapor retarder at a practical installed thickness as defined by a dry-cup permeance of less than or equal to 1 perm per ASTM E96, “Standard Test Methods for Water Vapor Transmission of Materials – Method A.” SPF used in roof systems, which are typically closed-cell, high-density, can typically perform as an air barrier and vapor retarder. SPF that is used for wall insulation, which is typically open-cell, low-density or closed-cell, medium density, may perform as an air barrier. Understanding the differences in characteristics of building products is important because similar products substituted on a job site could result in unintended consequences.



SPF USED AS AN AIR BARRIER

I-CODE REQUIREMENTS: COMMERCIAL BUILDINGS

GENERAL REQUIREMENTS FOR AIR BARRIERS

The I-Codes contain many specific requirements for air barriers, but in general they are required to be continuous for all assemblies in the building thermal envelope, including both roofs and walls. In addition, all joints, seams and penetrations in the air barrier must be sealed and secure enough to resist positive and negative pressures.

IECC REQUIREMENTS

The 2012 IECC Commercial Provisions contain a mandatory requirement for air barriers in Section C402.4.1; it states, “[a] continuous air barrier shall be provided throughout the building thermal envelope.” The 2012 IECC also provides air barrier performance requirements for material, assembly and whole building and includes specific test methods that are to be used to determine compliance. In comparison, the 2012 IECC Residential Provisions include mandatory requirements for air barriers (see Table R402.4.1.1 within the IRC), and only whole building performance requirements. The 2012 IECC Residential Provisions do not include specific test methods to be used to determine air leakage requirements.

COMMERCIAL AIR BARRIER REQUIREMENTS BY CLIMATE ZONE

CLIMATE ZONE	2012 IECC	2012 IgCC
1	Not Required	Required
2	Not Required	Required
3	Not Required	Required
4	Required	Required
5	Required	Required
6	Required	Required
7	Required	Required
8	Required	Required

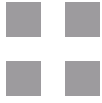

In order to comply with the requirements of the 2012 IECC, air barriers must meet one of three requirements: material, assembly or whole building. SPF at any thickness or density that meets or exceeds the air permeability requirement for “Material,” as shown in the chart, meets the requirements of the 2012 IECC. See 2012 IECC Section C402.4.1.2.1.

2012 IECC COMMERCIAL AIR BARRIER REQUIREMENTS FOR MATERIAL, ASSEMBLY AND BUILDING

AIR BARRIER TEST	AIR PERMEABILITY, MAX, OR AIR LEAKAGE, MAX ¹	PRESSURE DIFFERENTIAL
Material	0.004 cfm/sq. ft. (0.02 L/s · m ²)	0.3 inches of water (75 Pa)
Assembly	0.04 cfm/sq. ft. (0.2 L/s · m ²)	0.3 inches of water (75 Pa)
Building	0.4 cfm/sq. ft. (2.0 L/s · m ²)	0.3 inches of water (75 Pa)

NOTES TO THE TABLE

1. Air permeance is a characteristic specific to materials. Air leakage is a characteristic of an assembly or a whole building.

2012 IECC COMPLIANT SPF AIR BARRIERS

Although the 2012 IECC establishes testing and performance requirements for air barriers, the code also identifies specific materials that are prescriptively deemed to comply with the air barrier material performance requirements. Of the fifteen materials listed in the 2012 IECC that are prescriptively deemed to be air barriers, SPF materials are included as follows:

- Closed cell SPF a minimum density of 1.5 pcf (2.4 kg/m³) having a thickness of not less than 1½ inches (36 mm).
- Open cell SPF with a density between 0.4 and 1.5 pcf (0.6 and 2.4 kg/m³) and having a thickness of not less than 4.5 inches (113 mm).



SPF USED AS AN AIR BARRIER

SPF DETAILS: COMMERCIAL BUILDINGS

SPF MAY BE USED EITHER AS A COMPLETE AIR BARRIER SYSTEM OR AS LOCALIZED SUPPLEMENTAL AIR BARRIER USED WITH OTHER AIR BARRIER SYSTEMS. BECAUSE OF ITS SPRAY-IN-PLACE CHARACTERISTIC, SPF HAS THE ABILITY TO AIR-SEAL SPACES THAT ARE UNIQUE IN SIZE AND SHAPE.

SPF IN ROOF APPLICATIONS

When used as a component in a roof system, SPF effectively seals to penetrations and fills gaps. Therefore, special detailing of SPF roofs as air barriers can be minimal. If the air seal is located at the deck level, the SPF selected will depend on the specific characteristics desired.

Roof penetrations can be air sealed with SPF. H's, J's, I's as well as the more common circular or square penetrations can be air sealed with SPF. Roof penetrations are sealed with the same foam, or foam with similar characteristics, used for SPF roof systems, if the penetration is sealed at the surface of the roof system, since the same performance characteristics are needed.

SPF PENETRATION DETAIL: ROOF MEMBRANE AS AIR BARRIER

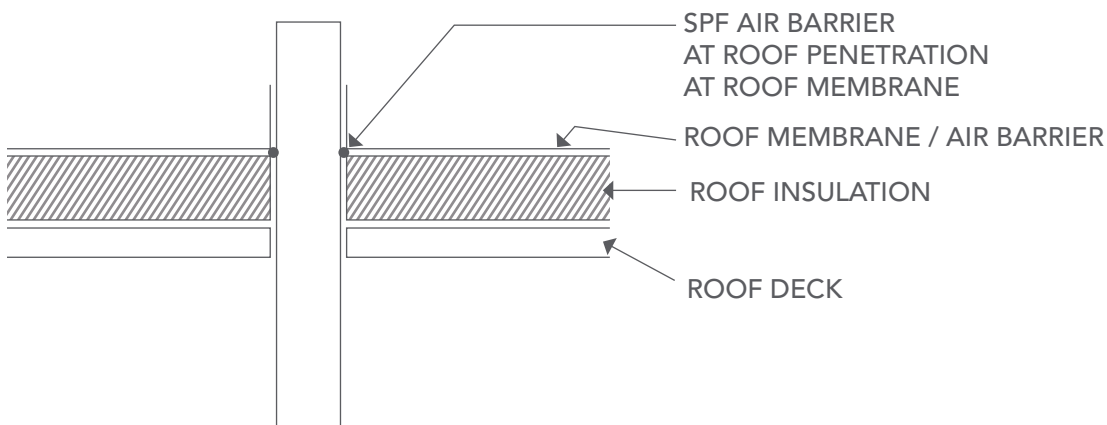

SPF PENETRATION DETAIL: AIR BARRIER BELOW ROOF INSULATION

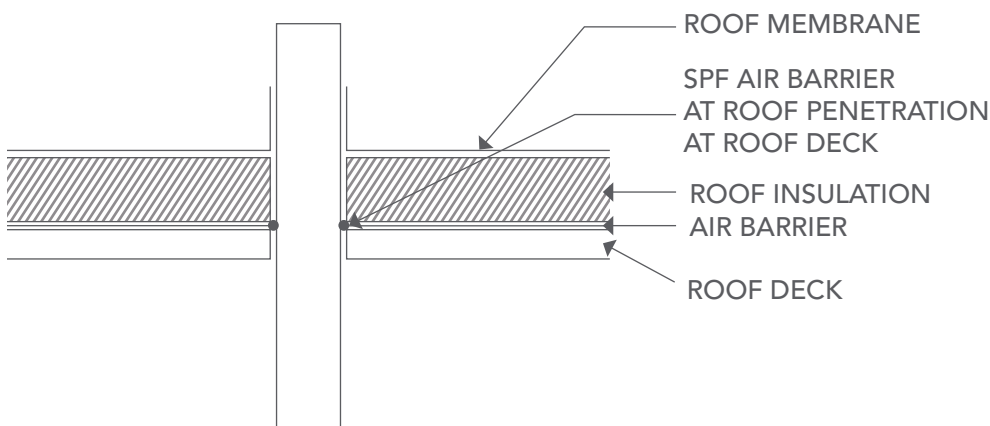



SPF ROOF / WALL INTERSECTION DETAIL: ROOF MEMBRANE AS AIR BARRIER

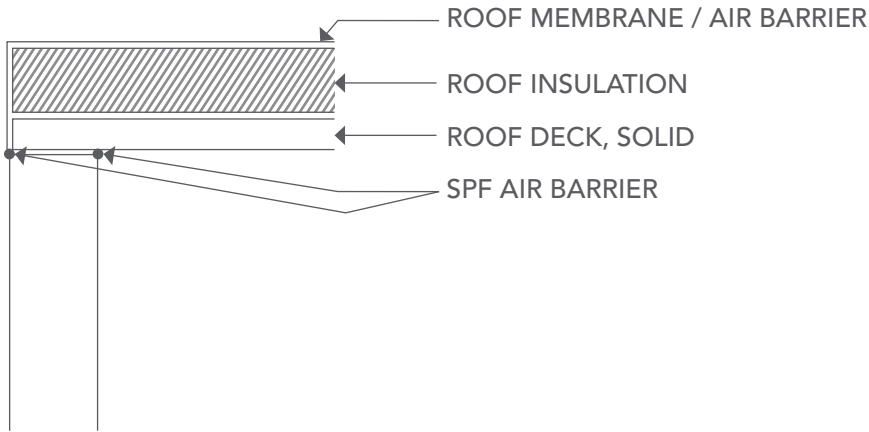

SPF ROOF / WALL INTERSECTION DETAIL: AIR BARRIER BELOW ROOF INSULATION

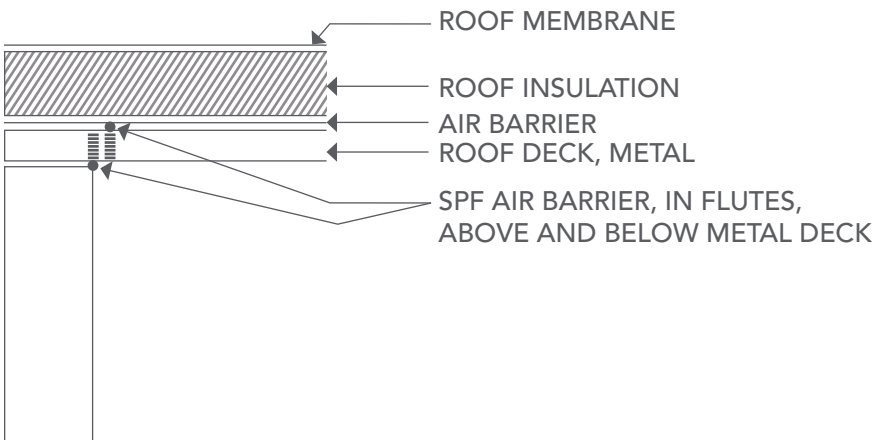

SPF ROOF / WALL INTERSECTION DETAIL: PARAPET WALL

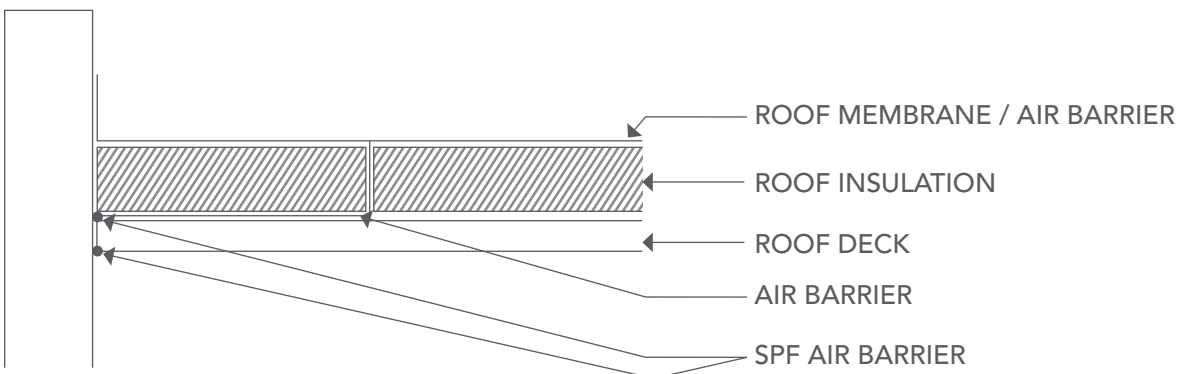



SPF IN WALL APPLICATIONS

When used as a wall insulation system, SPF effectively seals penetrations and fills gaps. Therefore, special detailing of SPF-insulated walls as air barriers is usually minimal; however, at windows, foundations and the top of the wall (the areas “outside” of the framing), an air barrier is required to be continuous within the building thermal envelope to be considered an air barrier under the 2012 IECC.

Wall penetrations can be air sealed with SPF. Wall penetrations are sealed with open cell, low-density foam to allow vapor to pass through the air seal, unless a vapor retarder is specifically required or desired.

SPF DETAILS: WALL PENETRATIONS AND TRANSITIONS

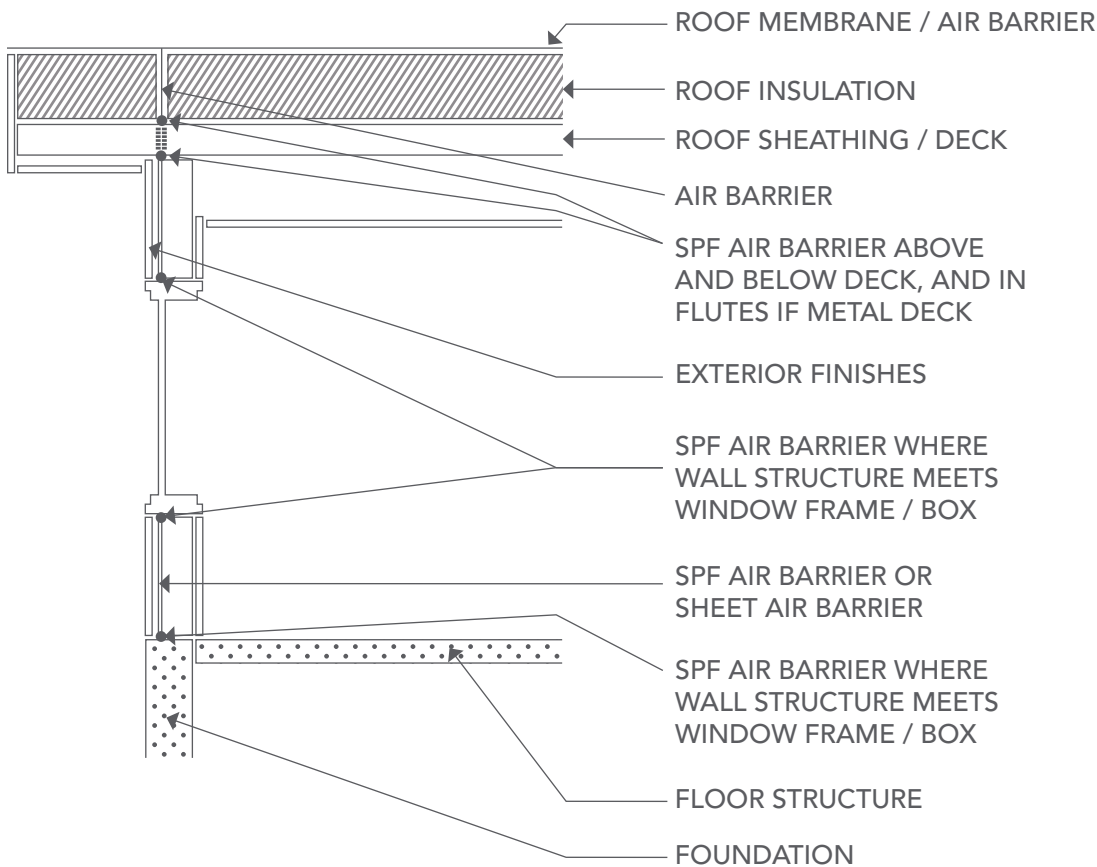

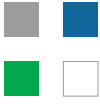

SPF USED AS AN AIR BARRIER

I-CODE REQUIREMENTS: RESIDENTIAL BUILDINGS

IECC REQUIREMENTS

The 2012 IECC Residential Provisions include a section regarding air leakage. The Residential Provisions do not specifically discuss air barriers, but provide requirements to limit air leakage of the building thermal envelope. Section R402.4 states, “[t]he building thermal envelope shall be constructed to limit air leakage . . .”

RESIDENTIAL AIR BARRIER REQUIREMENTS BY CLIMATE ZONE

CLIMATE ZONE	AIR CHANGES PER HOUR, MAX.	PRESSURE DIFFERENTIAL
1 – 2	5	0.2 inches of water (50 Pa)
3 - 8	3	0.2 inches of water (50 Pa)

NOTES TO THE TABLE

1. Specific test methods are not included in 2012 IECC for residential air leakage testing.

IgCC REQUIREMENTS

Although the 2012 IgCC does not include provisions for detached residential buildings (one- or two-family) and multi-family dwellings three stories or less in height, the requirements of the 2012 IECC remain as minimum requirements for all residential buildings in jurisdictions that have adopted the 2012 IECC.



SPF USED AS AN AIR BARRIER

SPF DETAILS: RESIDENTIAL BUILDINGS

SPF MAY BE USED EITHER AS A COMPLETE AIR BARRIER SYSTEM OR AS A LOCALIZED SUPPLEMENTAL AIR BARRIER COMPONENT USED WITH OTHER AIR BARRIER SYSTEMS. BECAUSE OF ITS SPRAY-IN-PLACE CHARACTERISTIC, SPF HAS THE ABILITY TO AIR SEAL SPACES THAT ARE UNIQUE IN SIZE AND SHAPE.

SPF IN ROOF APPLICATIONS

When used as a roof system, SPF can effectively seal penetrations and fills gaps. Therefore, special detailing of SPF roofs as air barriers is minimal. If the air seal is located at the deck level, the SPF formulation used will depend on the specific characteristics needed.

Roof penetrations can be air sealed with SPF. Roof penetrations are sealed with the same foam, or foam with the same characteristics, used for SPF roof systems if the penetration is sealed at the surface of the roof system, since the same performance characteristics are needed.

SPF PENETRATION DETAIL: ROOF PENETRATION SEAL

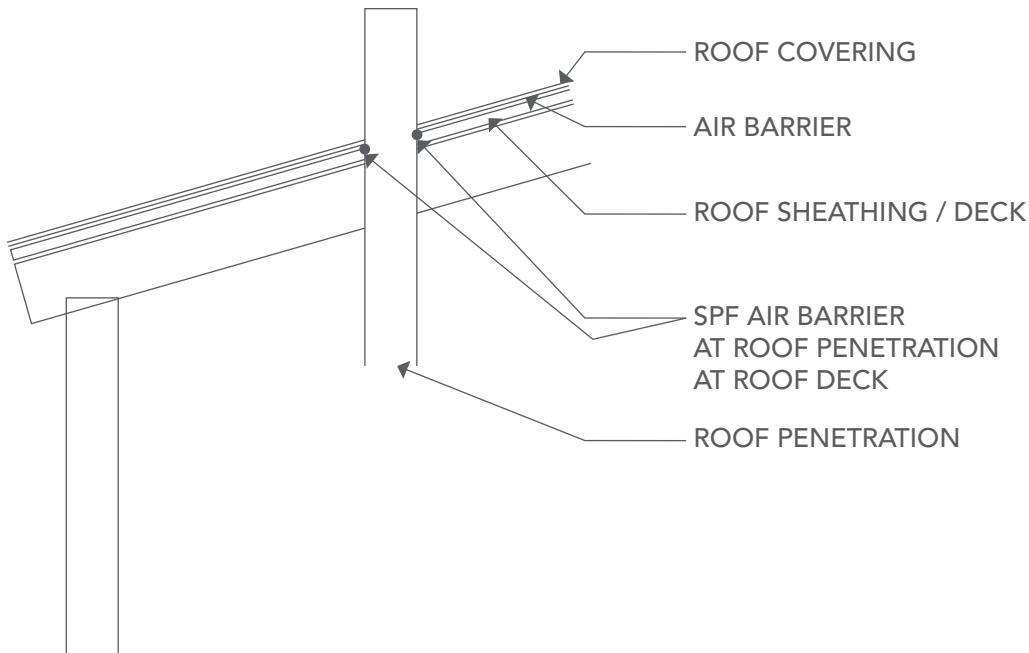

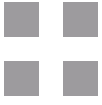

SPF PENETRATION DETAIL: UNDER DECK INSULATION SEAL

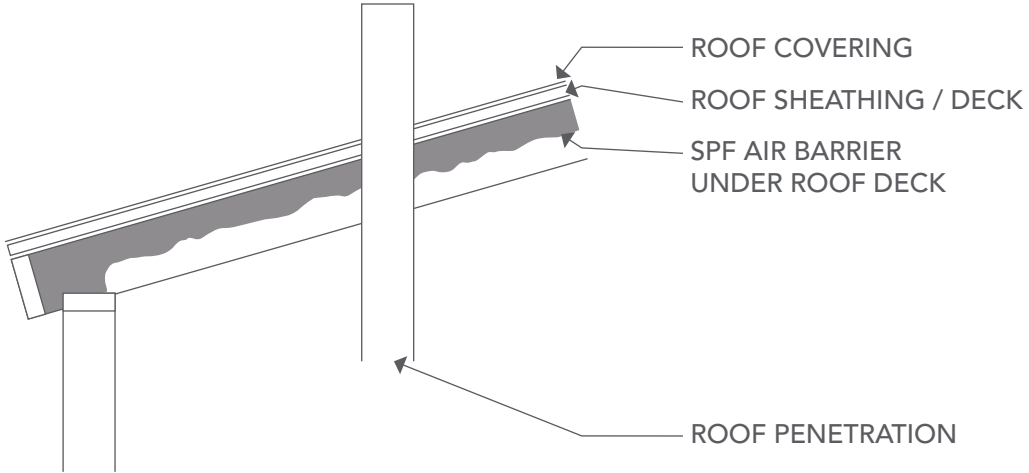

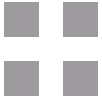

SPF IN WALL APPLICATIONS

When used as a wall insulation system, SPF seals penetrations and fills gaps. Therefore, special detailing of SPF-insulated walls as air barriers is minimal; however, at windows, foundations and the top of the wall (the areas “outside” of the framing), an air barrier is needed to be continuous within the building thermal envelope.

Wall penetrations can be air sealed with SPF. Wall penetrations are sealed with open cell, low-density foam to allow vapor to pass through the air seal, unless a vapor retarder is specifically required or desired.

SPF DETAILS: WALL PENETRATIONS AND TRANSITIONS

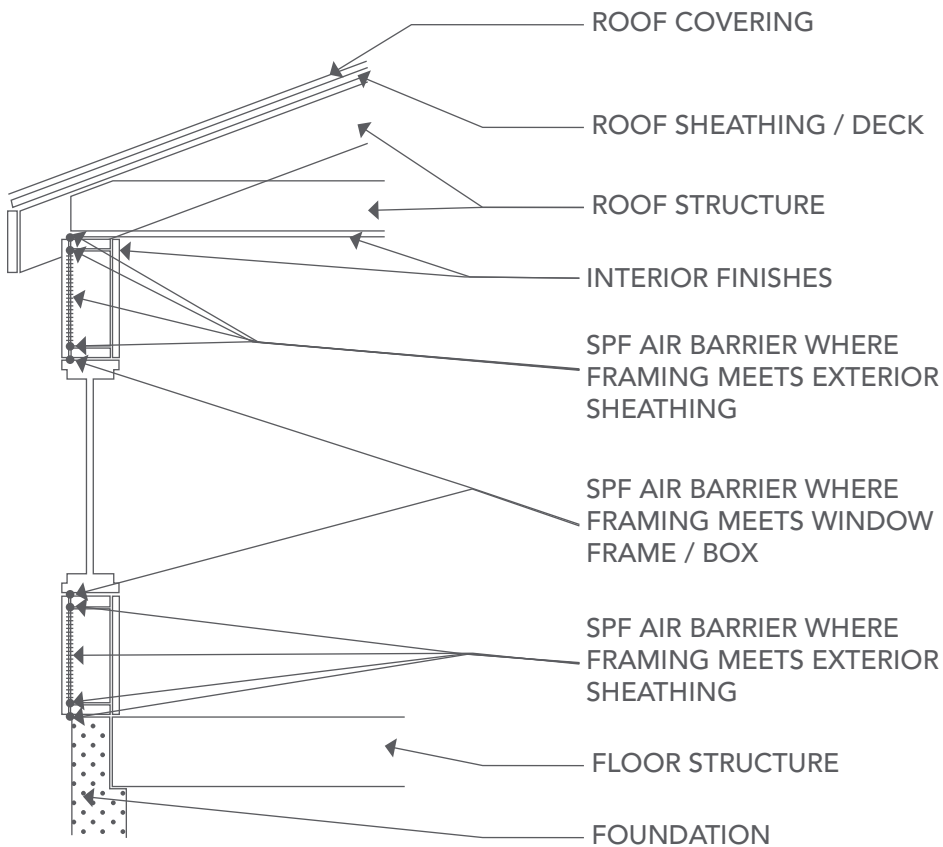

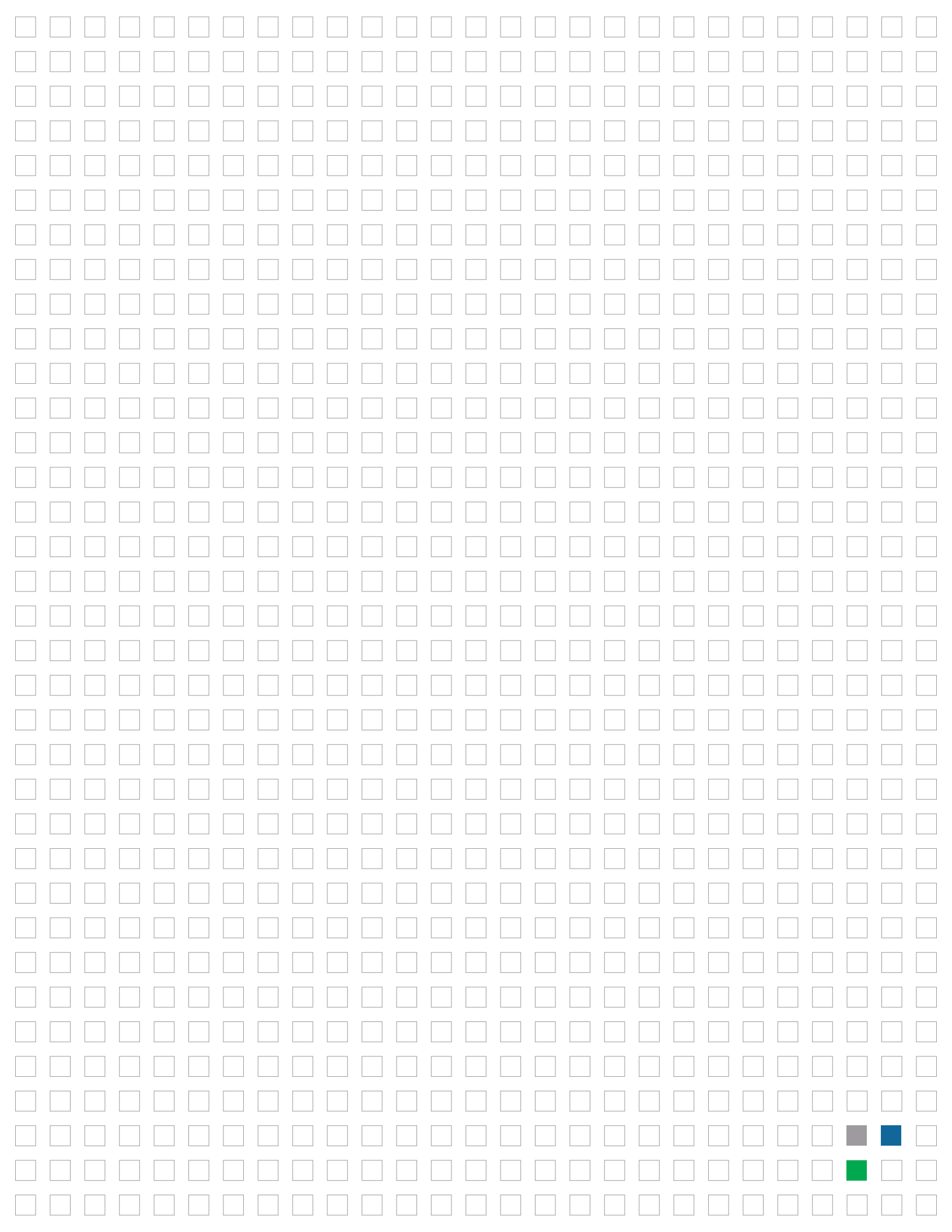



DISCLAIMER

THIS GUIDANCE DOCUMENT IS OFFERED FOR THE SOLE PURPOSE OF PROVIDING GENERAL, NON-EXPERT INFORMATION REGARDING THE PRESCRIPTIVE INSULATION AND AIR BARRIER REQUIREMENTS OF THE 2012 I-CODES (AND ASHRAE BUILDING ENERGY STANDARDS). THIS GUIDANCE DOES NOT ADDRESS ANY OTHER DESIGN OR SAFETY REQUIREMENTS OF ANY OF THE OTHER I-CODES. THE PUBLISHERS OF THIS GUIDANCE DOCUMENT DISCLAIM ANY LIABILITY UNDER ANY THEORY OF LAW FOR THE INFORMATION CONTAINED IN THIS GUIDANCE DOCUMENT, ITS ACCURACY AND ITS SUITABILITY FOR APPLICATION TO BUILDING ENVELOPE ASSEMBLIES (ROOF AND WALL) FOR ANY GIVEN BUILDING PROJECT IN ANY CODE JURISDICTION.

The information provided in this guidance document should not be construed to represent aesthetics or other attributes not specifically addressed, nor should it be construed as an endorsement of the information in this guidance document or a recommendation for its use. Readers of this guidance document should consult with the local building code authorities before applying information in this guidance document to any building design or project.

This guidance document is intended to provide general information to professional persons who may be involved in installing spray polyurethane foam in commercial and residential building construction. It is not intended to serve as a substitute for in-depth training or specific construction or code requirements, nor is it designed or intended to define or create legal rights or obligations. It is not intended to be a "how-to" manual, nor is it a prescriptive guide. All persons involved in construction projects including spray polyurethane foam have an independent obligation to ascertain that their actions are in compliance with current federal, state and local laws, codes, and regulations and should consult with legal counsel concerning such matters. The guidance is necessarily general in nature and individuals may vary their approach with respect to particular practices based on specific factual circumstance, the practicality and effectiveness of particular actions and economic and technological feasibility. Neither the American Chemistry Council, nor the individual member companies of the Center for the Polyurethanes Industry, the Spray Foam Coalition of the American Chemistry Council, the Center for Environmental Innovation in Roofing, nor any of their respective directors, officers, employees, subcontractors, consultants, or other assigns, makes any warranty or representation, either express or implied, with respect to the accuracy or completeness of the information contained in this guidance document; nor do the American Chemistry Council, the Center for the Polyurethanes Industry, the Spray Foam Coalition, the Center for Environmental Innovation in Roofing, or any member companies assume any liability or responsibility for any use or misuse, or the results of such use or misuse, of any information, procedure, conclusion, opinion, product, or process disclosed in this document. NO WARRANTIES ARE GIVEN; ALL IMPLIED WARRANTIES OF MERCHANTABILITY OR FITNESS FOR A PARTICULAR PURPOSE ARE EXPRESSLY EXCLUDED.

This guidance document is protected by copyright. Users are granted a nonexclusive royalty-free license to reproduce and distribute, subject to the following limitations: (1) the work must be reproduced in its entirety, without alterations; and (2) copies of the work may not be sold.

